

The following talk has been approved by the
NO STAR WARS VII SPOILERS
association of Star Wars fans.

THIS TALK HAS BEEN RATED



Arnaud LAURET
@apihandyman

AXA Banque

A not so long time ago in an APIverse
not so far, far away....

I

II

III

IV

V

VI

VII

Episode 1

SYNNECROSIS MENACE

Turmoil has engulfed the API-verse. The documentation of API systems is in dispute.

The API Evangelist, the guardian of peace and justice in the

38

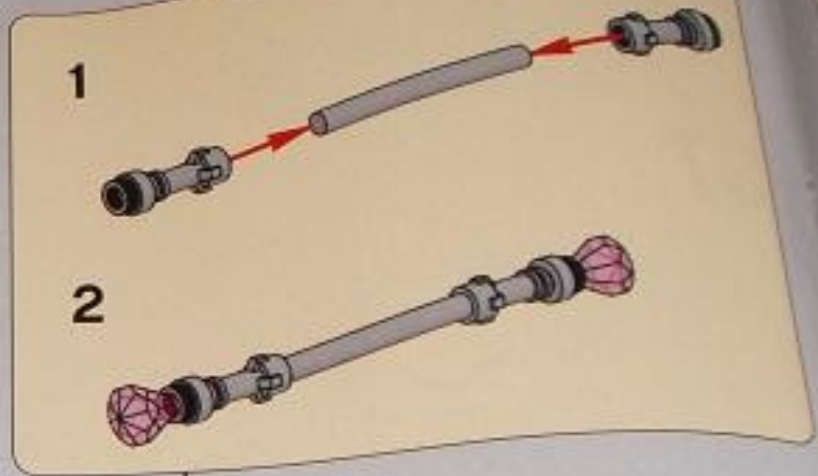
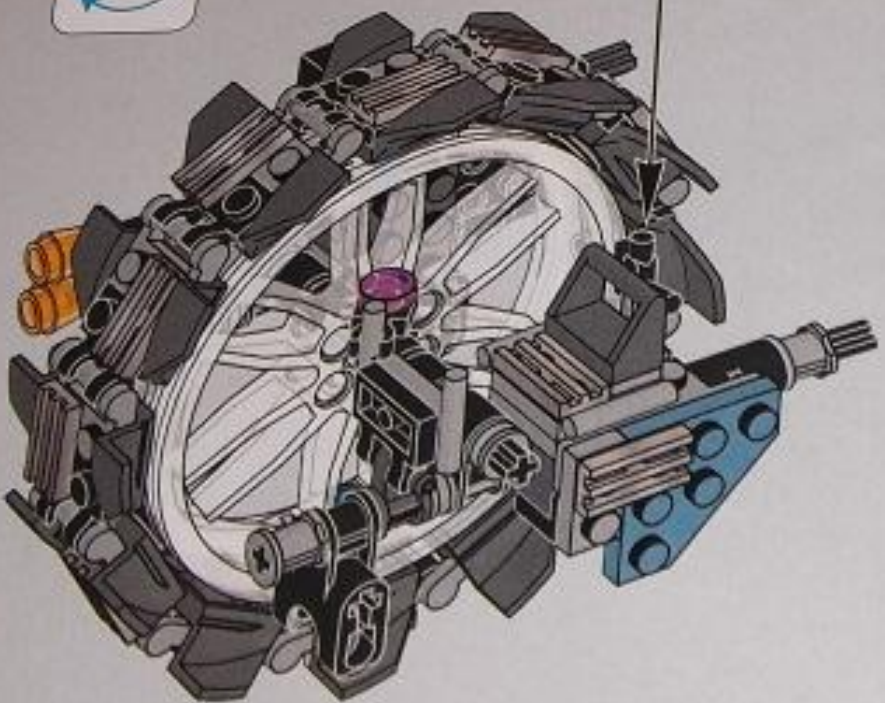

38

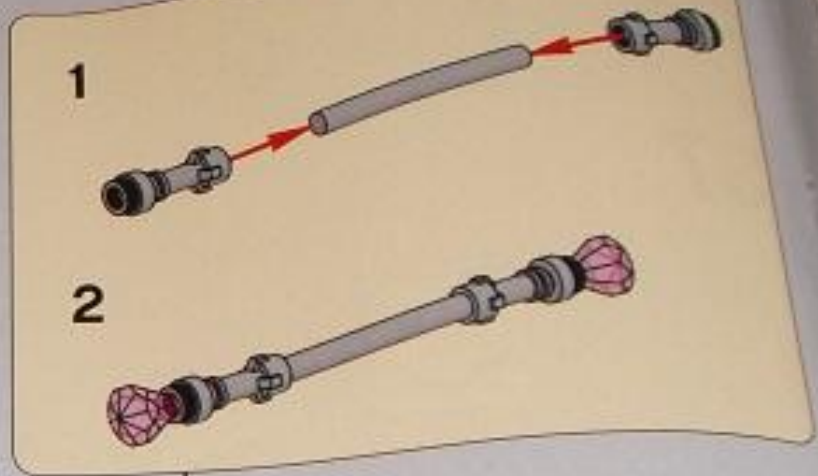
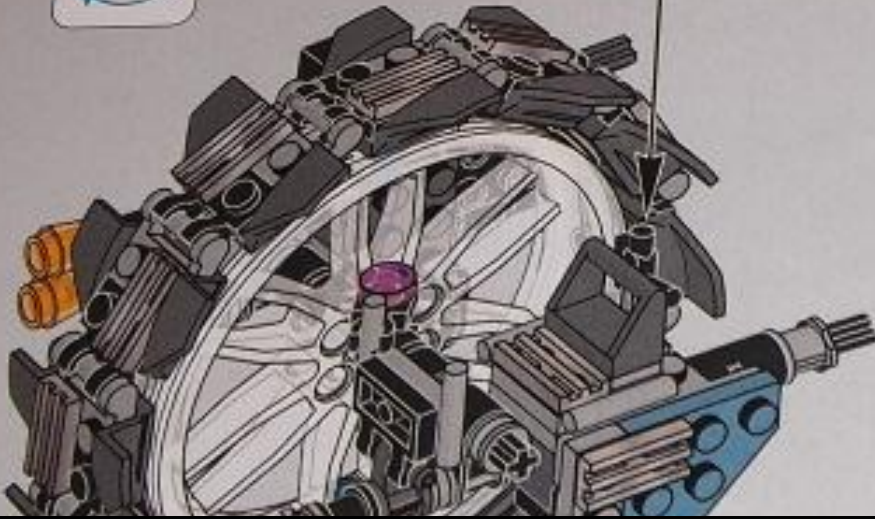

Documentation is NOT ONLY end user's one

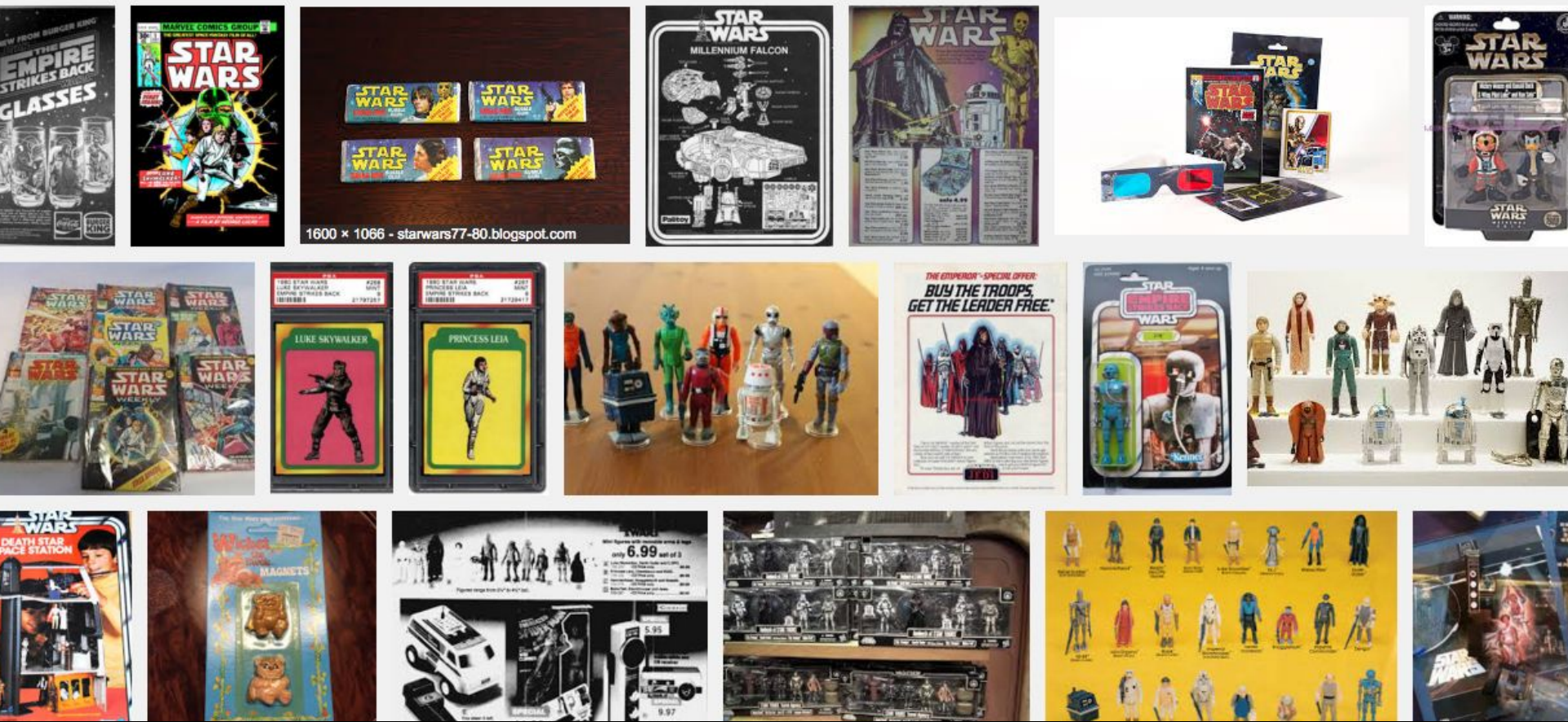

1600 x 1066 - starwars77-80.blogspot.com

Many different forms and audiences

HAYNES MANUALS

DEATH STAR

Imperial Department of Military Research

Owners Workshop Manual



Front View

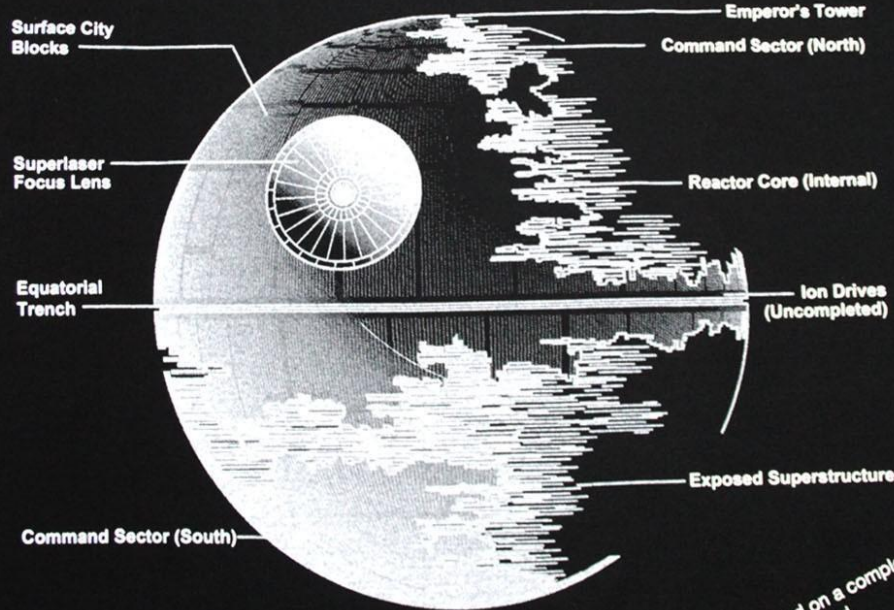

Every manual based on a complete
strip down and
rebuild.

Every instructions,
comments and
information needed to
build, maintain and
use an API and its
subsystems





API and documentation
are more than related



Symbiotic relationship



Close and often long-term interaction
between 2 different species

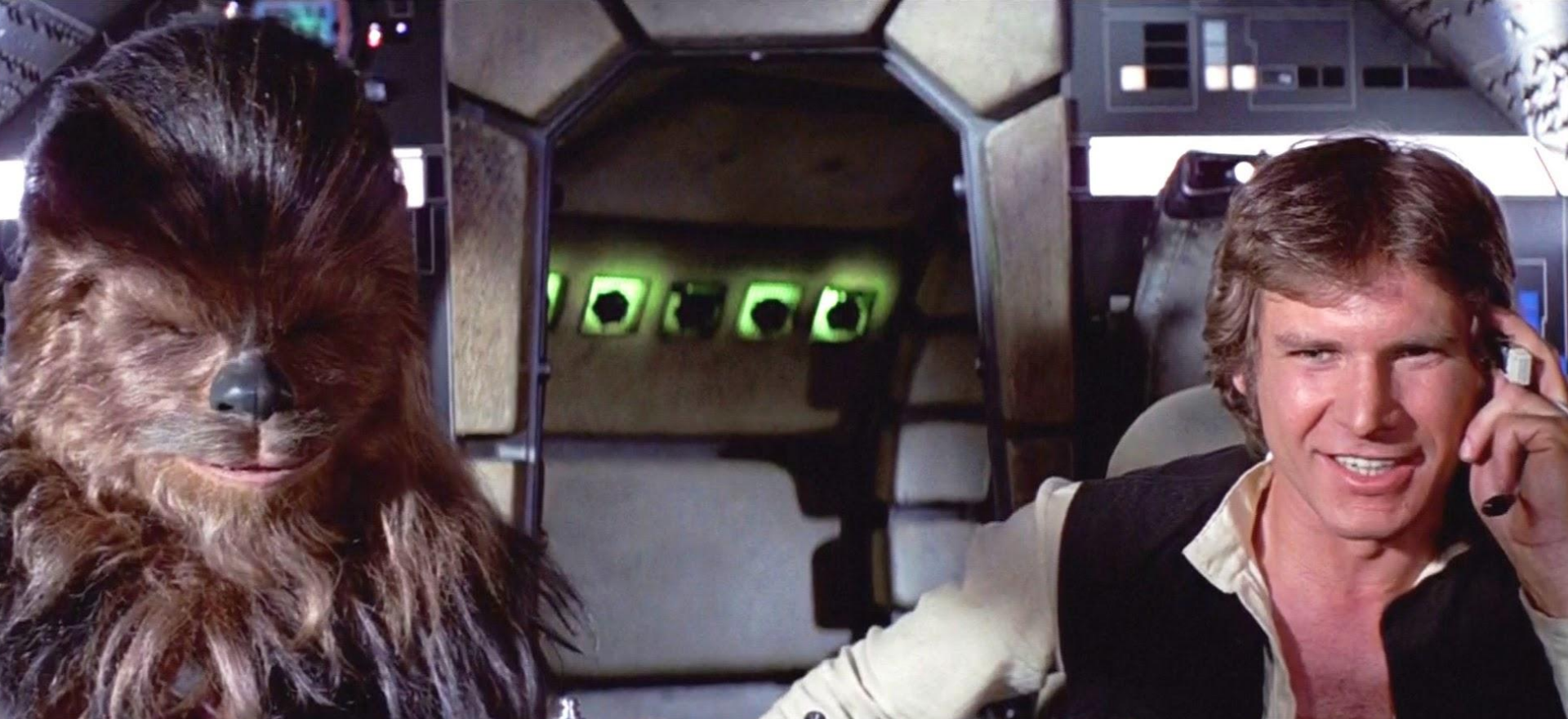

Mutualism

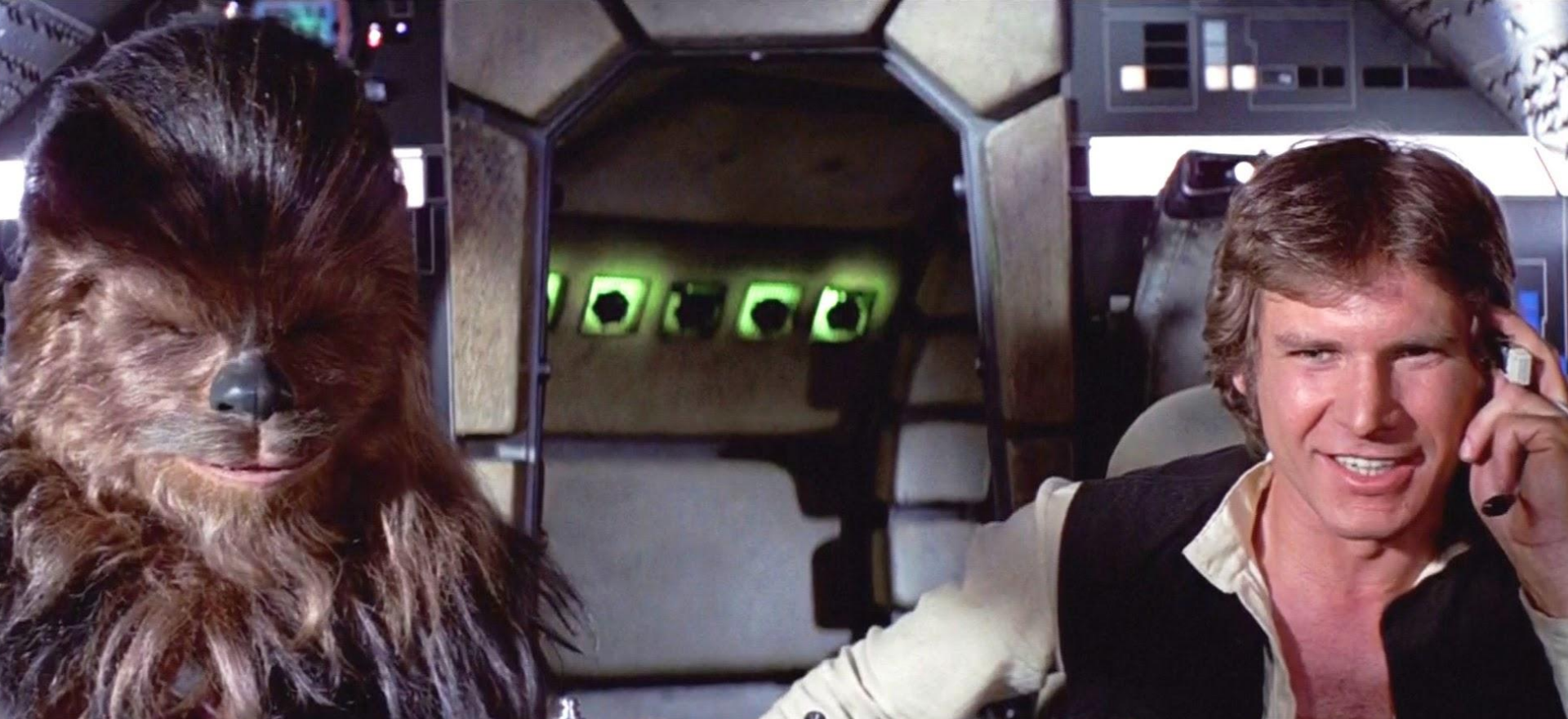

Both individuals benefit





Parasitism



One benefits, One is harmed





Synnecrosis



Detrimental to both



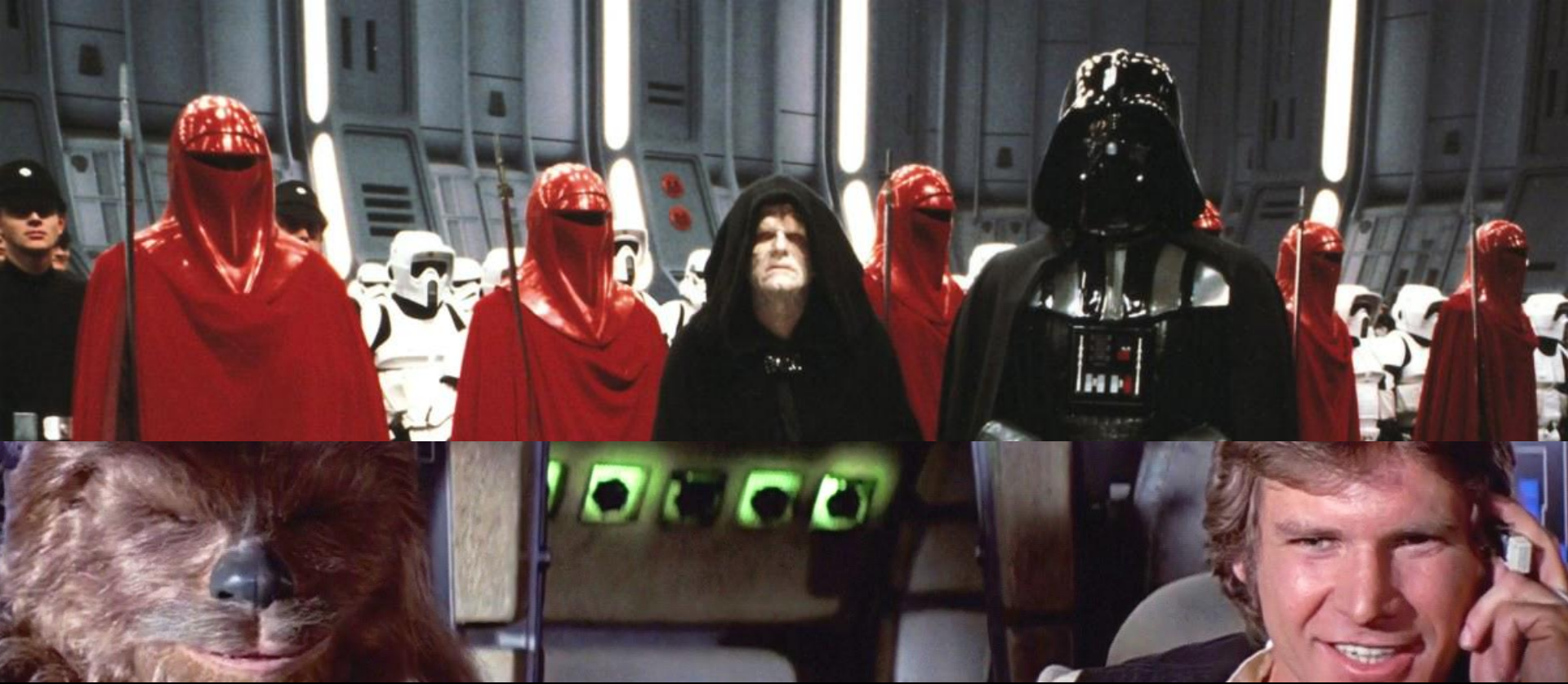

API & Documentation succeed together
or fall to the dark side

TAKEAWAYS

Episode I DOCUMENTATION MATTERS

I

II

III

IV

V

VI

VII

Episode II

ATTACK OF THE UNREAD

*There is unrest in the API
Senate. Thousands
documentations have been
written but never read or used.*

*Jen Riggo must quickly find out
why, to prevent APIverse's
collapse...*



Unread documentation



Right people write the right documentation
for the right audience and right context.



Creating documentation is a real job



Document only when needed



Adapted to the subject



Adapted to the audience



Adapted to the context





Standardized



Standardized API and subsystems



Standardized documentation





Micronized



Microservices



Microdocumentations

Side View Cutaway
(probot in space pod)

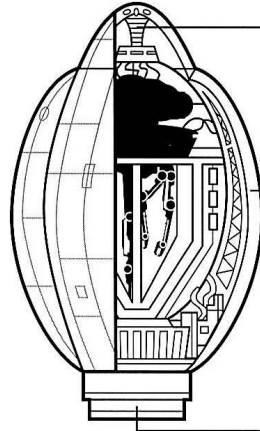

Atmospheric Sampler
High-Intensity Floodlight
Broadcast Antennae
Sensor Array

Visual Sensor (3)
Hyperdrive Pod
Infrared Sensor

Thrust Port
Repulsorlift
Drive Unit
Sublight/Hyperdrive
Engines

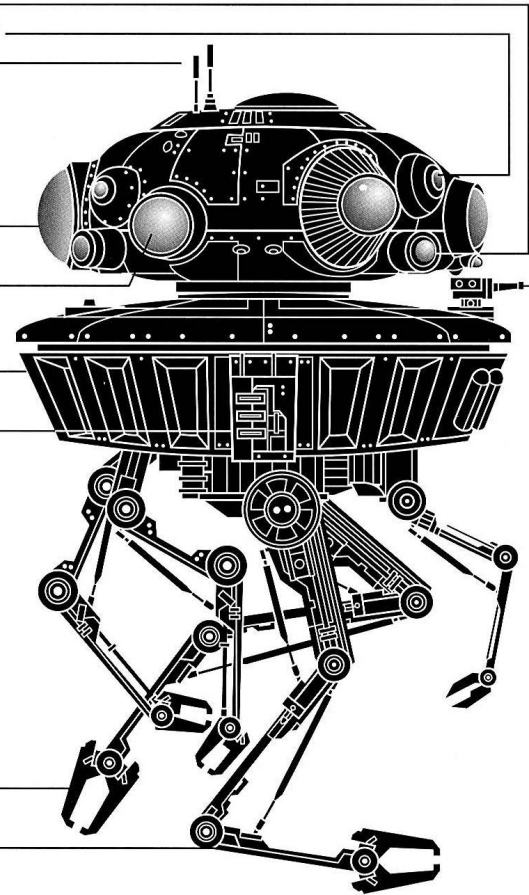

Manipulator Arm

High-Torque Arm

Laser Cannon

Side View

Side View Cutaway
(probot in space pod)

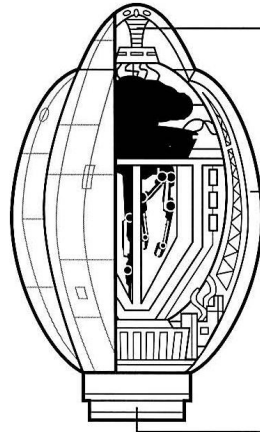

Atmospheric Sampler
High-Intensity Floodlight
Broadcast Antennae
Sensor Array

Visual Sensor (3)
Hyperdrive Pod
Infrared Sensor

Thrust Port
Repulsorlift
Drive Unit
Sublight/Hyperdrive
Engines

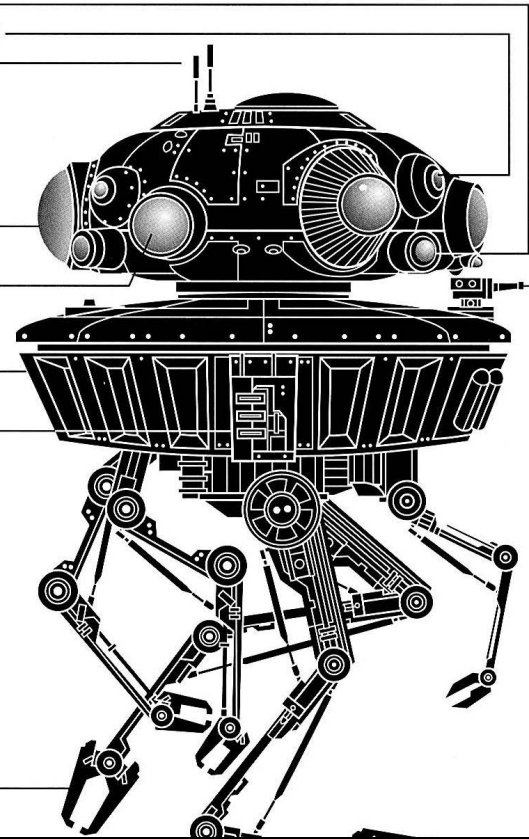

Manipulator Arm

Analyzed and Tracked

Side View Cutaway
(probot in space pod)

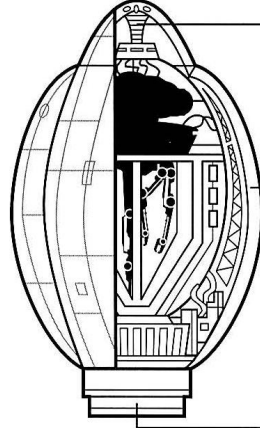

Atmospheric Sampler
High-Intensity Floodlight
Broadcast Antennae
Sensor Array

Visual Sensor (3)
Hyperdrive Pod
Infrared Sensor

Thrust Port
Repulsorlift
Drive Unit
Sublight/Hyperdrive
Engines

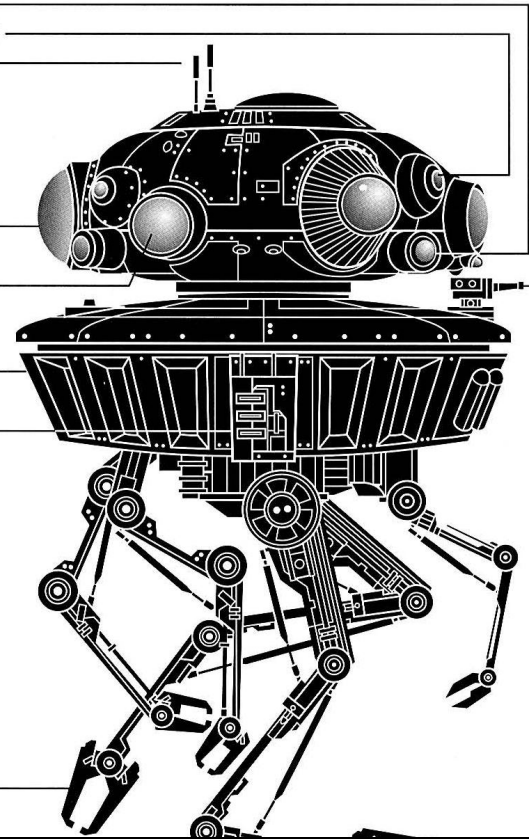

Manipulator Arm

Consistent with dependancies

Side View Cutaway
(probot in space pod)

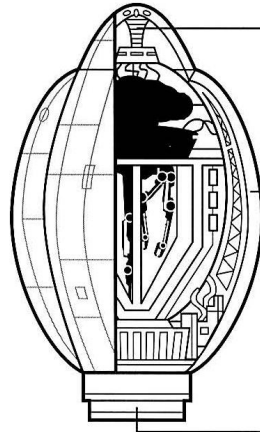

Atmospheric Sampler
High-Intensity Floodlight
Broadcast Antennae
Sensor Array

Visual Sensor (3)
Hyperdrive Pod
Infrared Sensor

Thrust Port
Repulsorlift
Drive Unit

Sublight/Hyperdrive
Engines

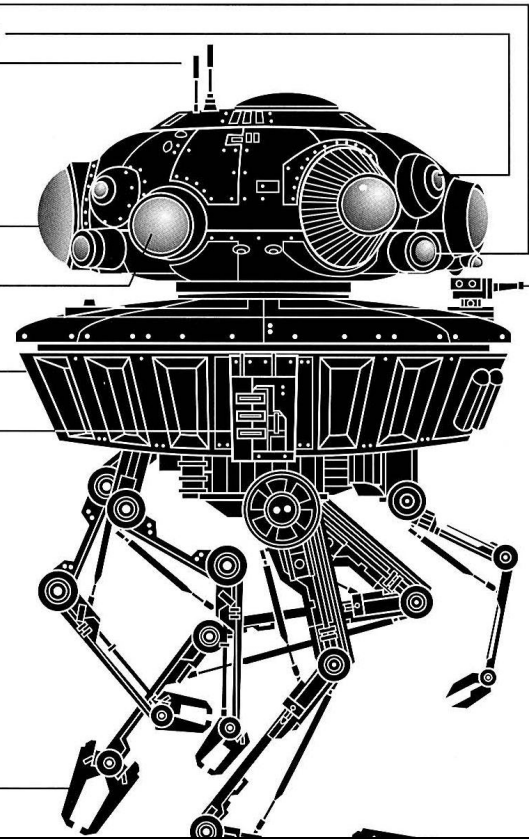

Manipulator Arm

Consistent with subject

Side View Cutaway
(probot in space pod)

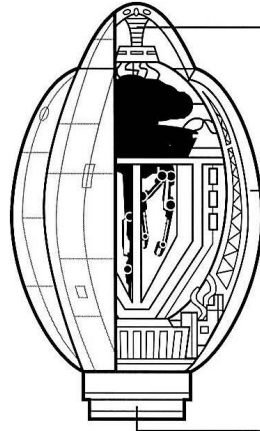

Atmospheric Sampler
High-Intensity Floodlight
Broadcast Antennae
Sensor Array

Visual Sensor (3)
Hyperdrive Pod
Infrared Sensor

Thrust Port
Repulsorlift
Drive Unit
Sublight/Hyperdrive
Engines

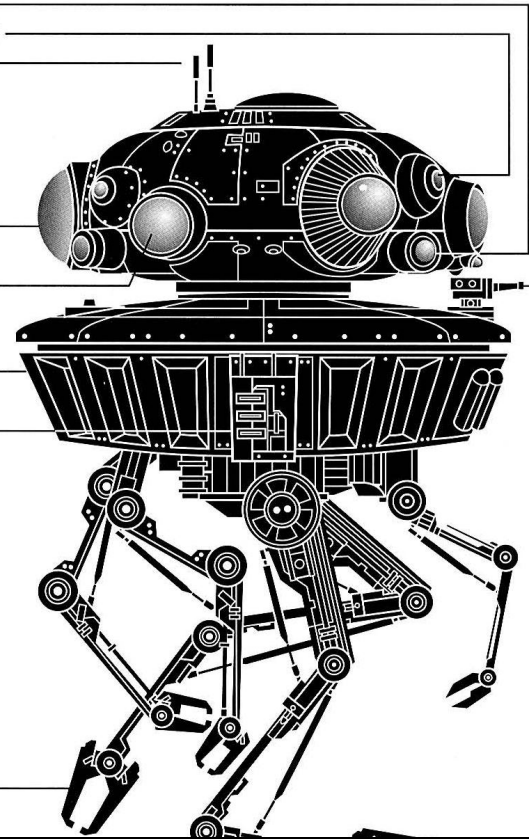

Manipulator Arm

Usage

Side View Cutaway
(probot in space pod)

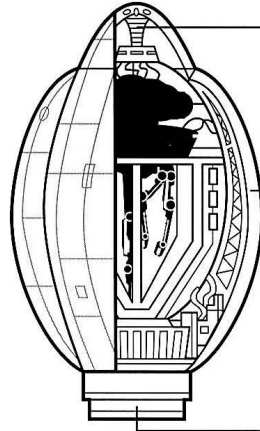

Atmospheric Sampler
High-Intensity Floodlight
Broadcast Antennae
Sensor Array

Visual Sensor (3)
Hyperdrive Pod
Infrared Sensor

Thrust Port
Repulsorlift
Drive Unit
Sublight/Hyperdrive
Engines

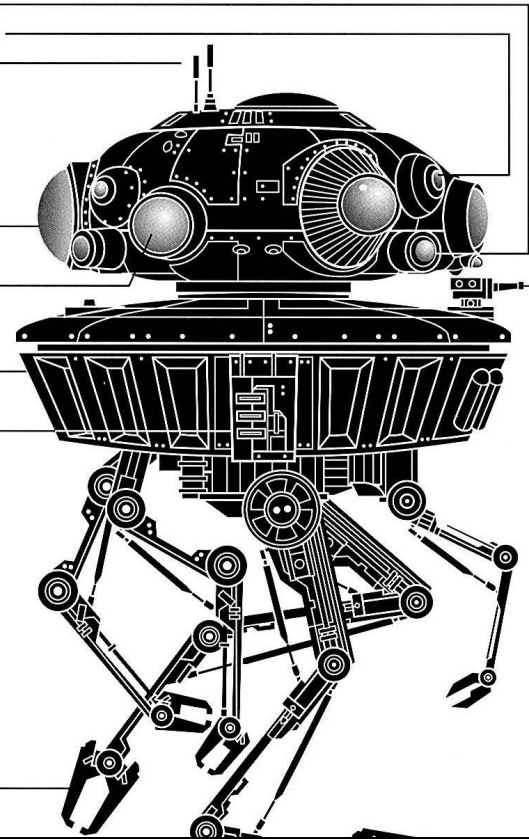

Manipulator Arm

Referenced

TAKEAWAYS

Episode I DOCUMENTATION MATTERS
Episode II FIGHT UNREAD DOCUMENTATION

I

II

III

IV

V

VI

VII

Episode III

REVENGE OF THE CODE

War! The Documentation Republic is crumbling under attacks by the ruthless binary document format, Count Word.

In a stunning move, a cunning document format, General Braul Puce, has swept into the



Where do you think you're going? =====





Documentation as code



Structured text
Human and machine readable



Documentation Version Control System

STAR WARS FAMILY TREE

OFFSPRING	—————
ROMANCE	- - - - -
SIGNIFICANT BATTLE	—————
APPRENTICE / MASTER	- - - - -
FRIENDSHIP	—————
OTHER	- - - - -

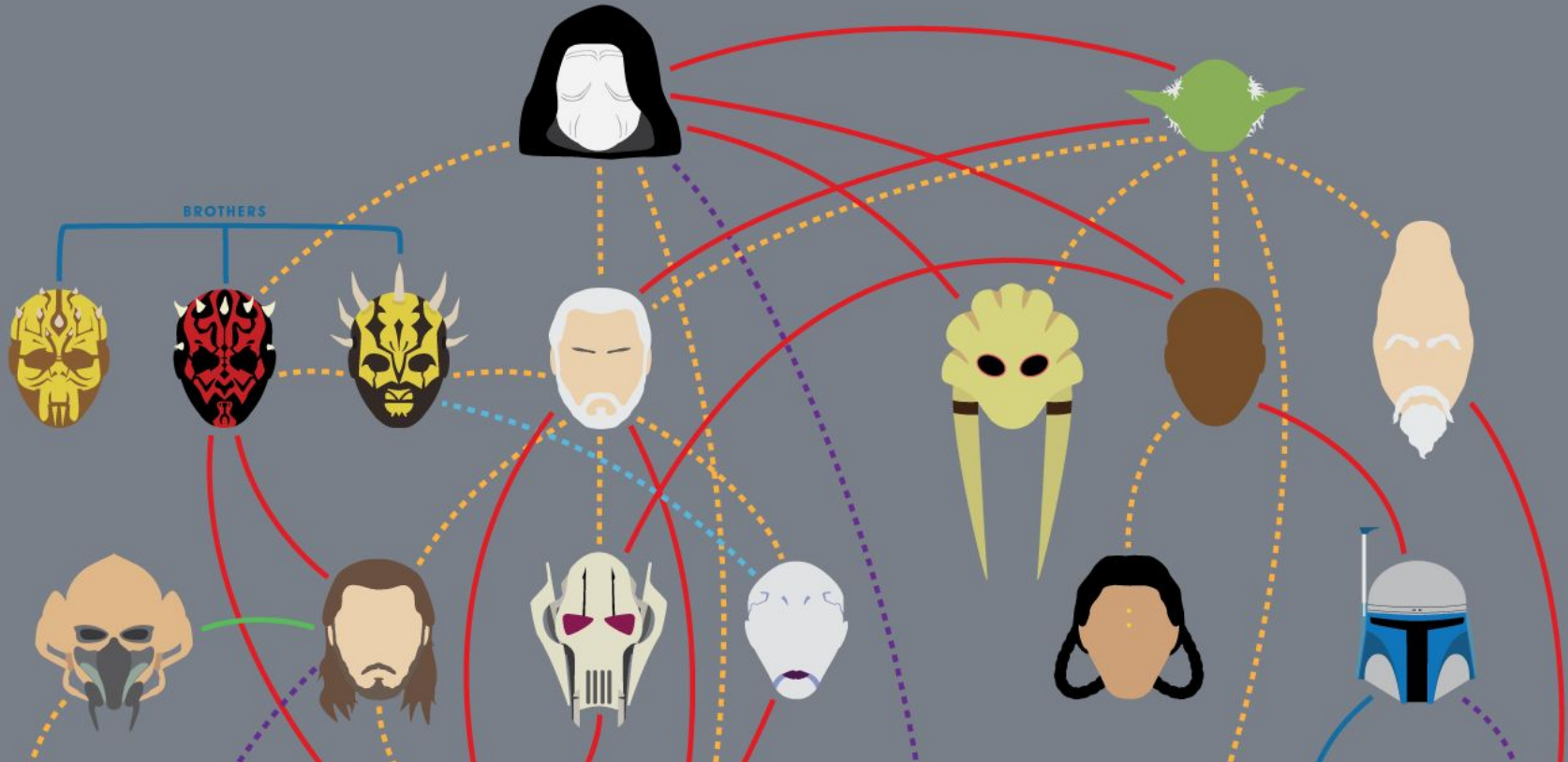

STAR WARS FAMILY TREE

OFFSPRING	————
ROMANCE	- - - -
SIGNIFICANT BATTLE	————
APPRENTICE / MASTER	- - - -
FRIENDSHIP	————
OTHER	- - - -

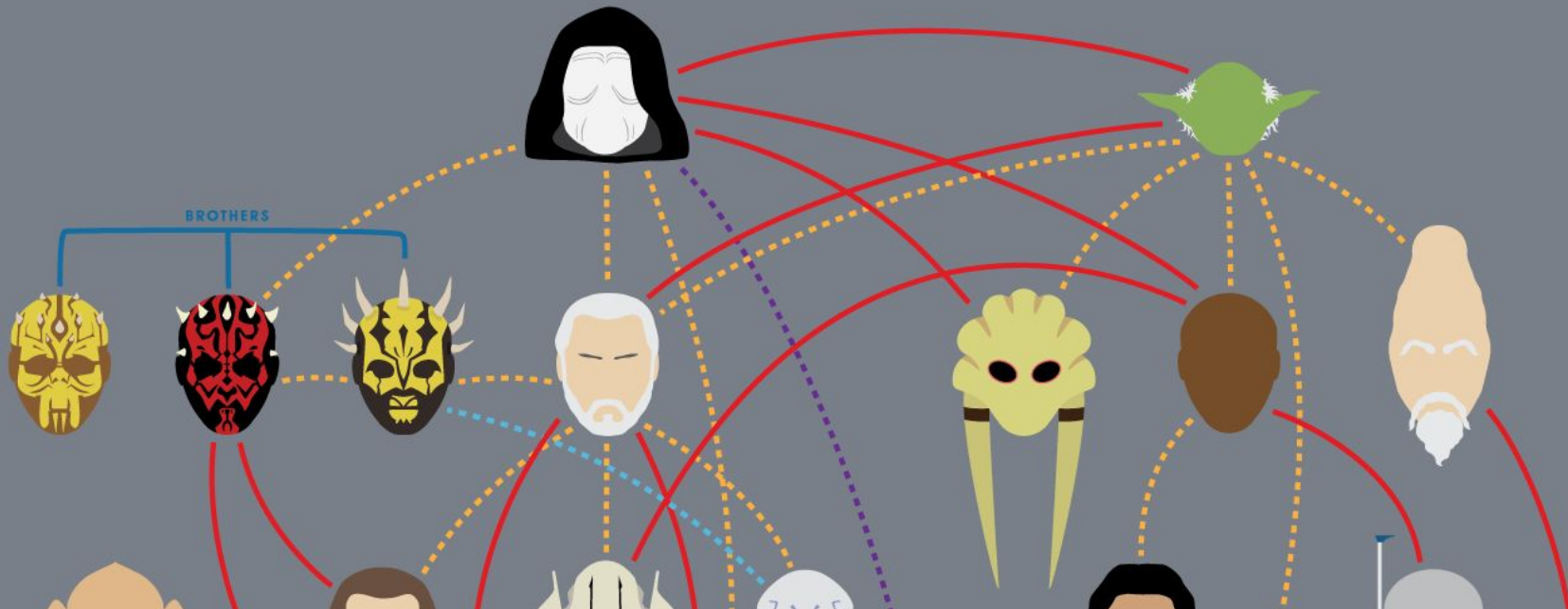

Documentation Package Manager

STAR WARS FAMILY TREE

- OFFSPRING —————
- ROMANCE - - - - -
- SIGNIFICANT BATTLE - - - - -
- APPRENTICE / MASTER - - - - -
- FRIENDSHIP - - - - -
- OTHER - - - - -

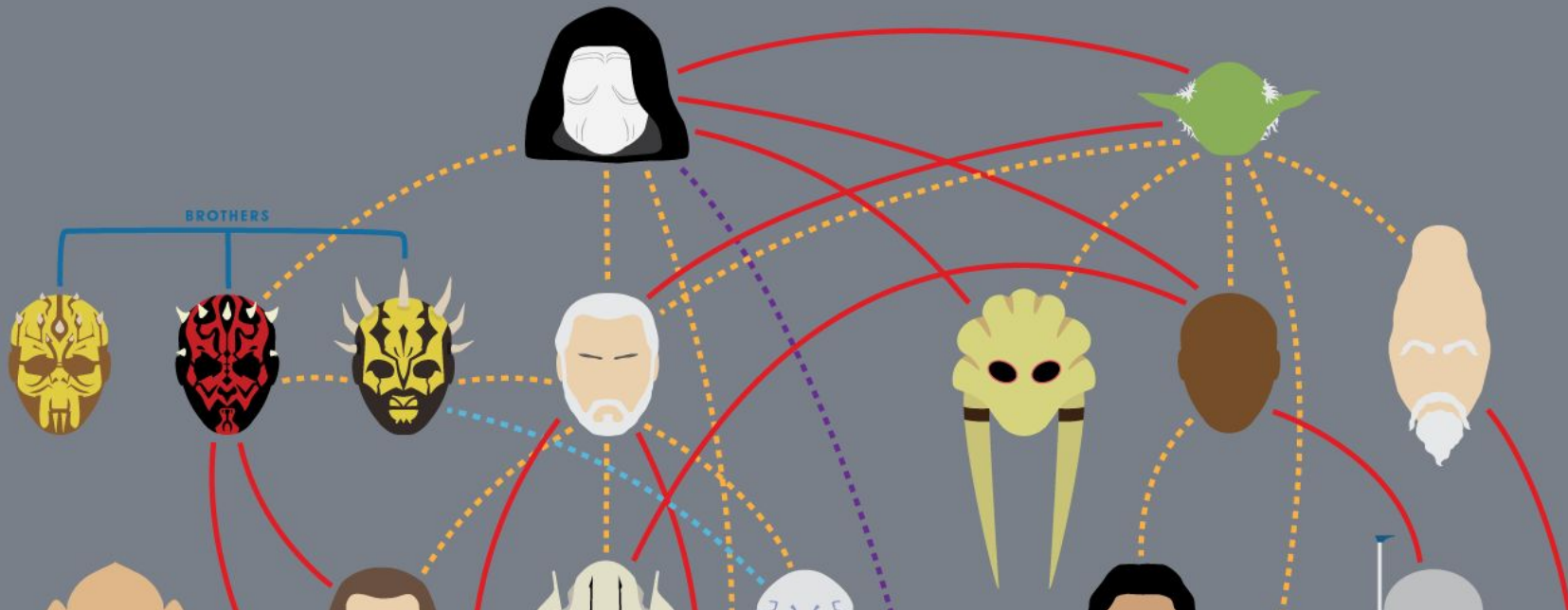

DPM search

STAR WARS FAMILY TREE

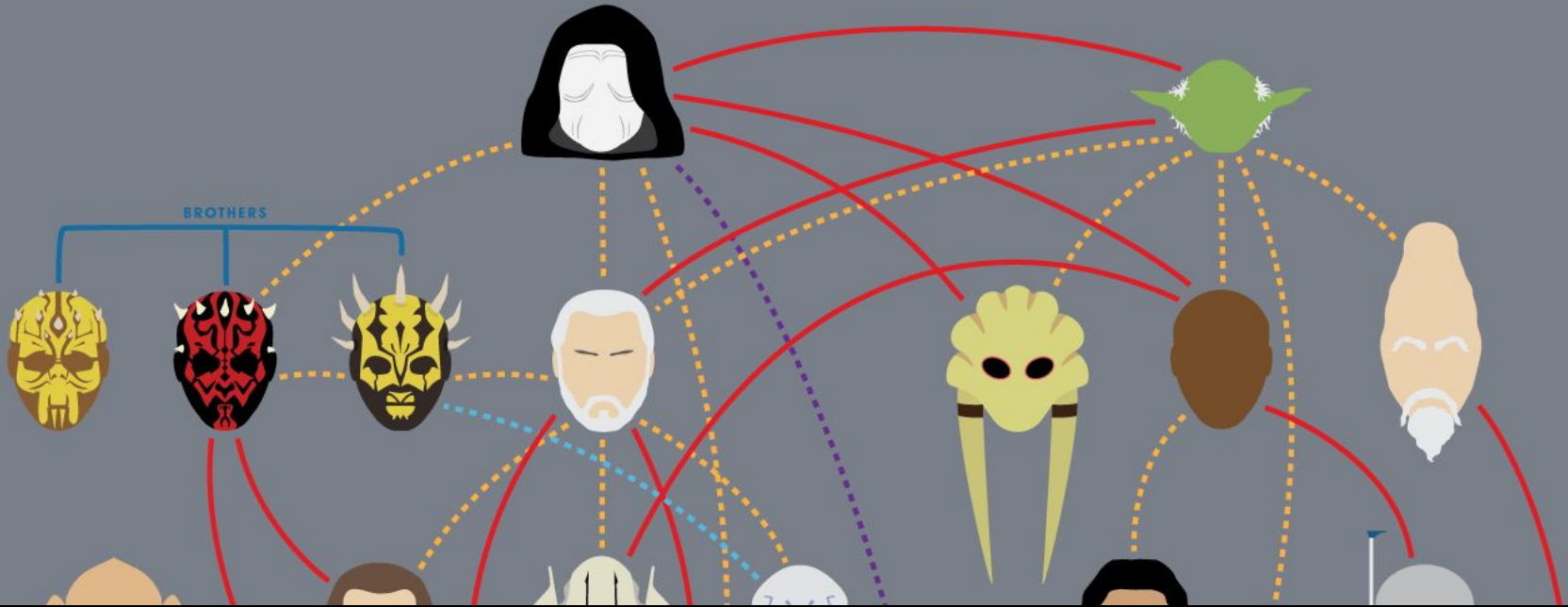

DPM install api-guidelines --save-doc

STAR WARS FAMILY TREE

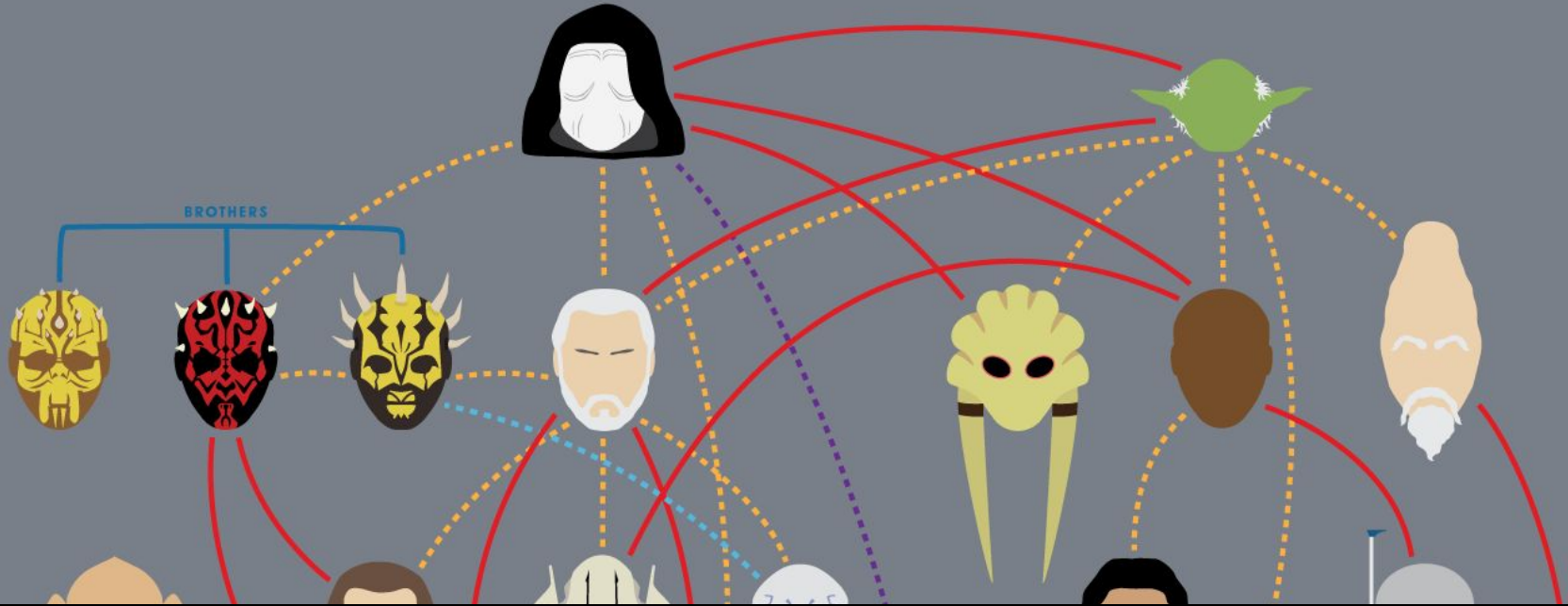

DPM link my-api --save-impl

STAR WARS FAMILY TREE

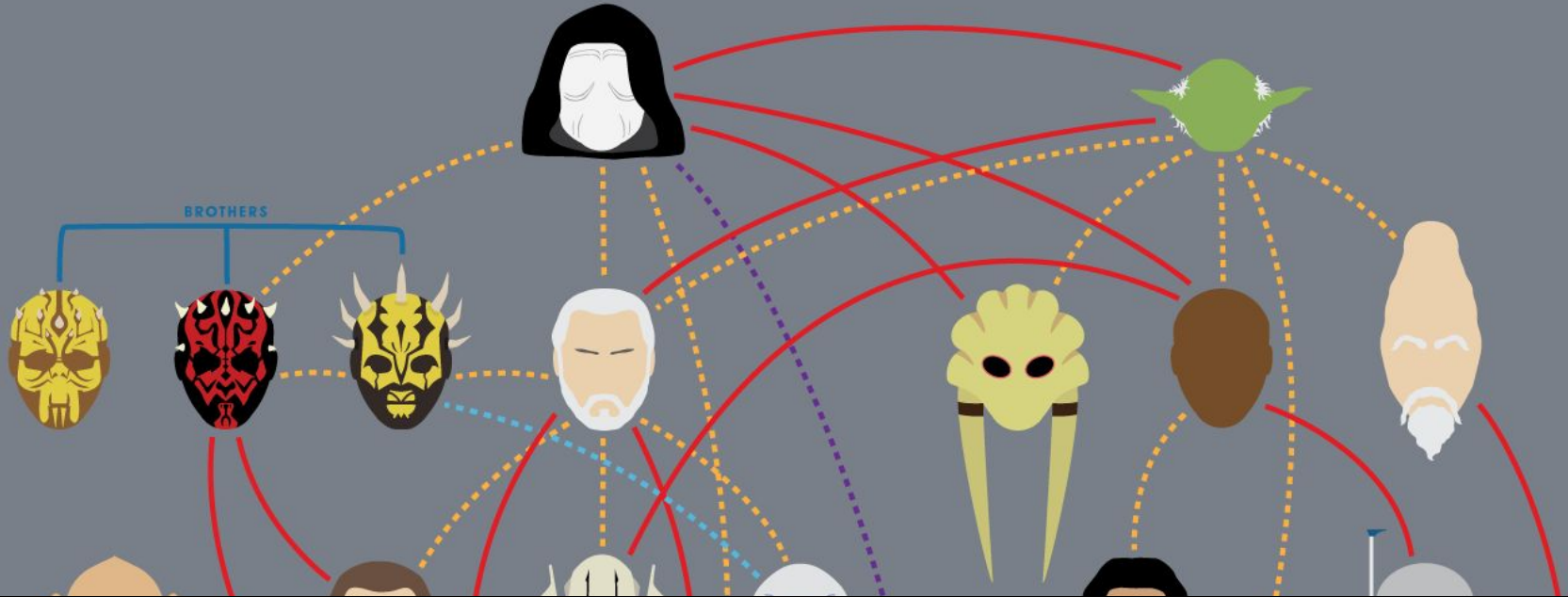

Consistency checked using DPM descriptor

STAR WARS FAMILY TREE

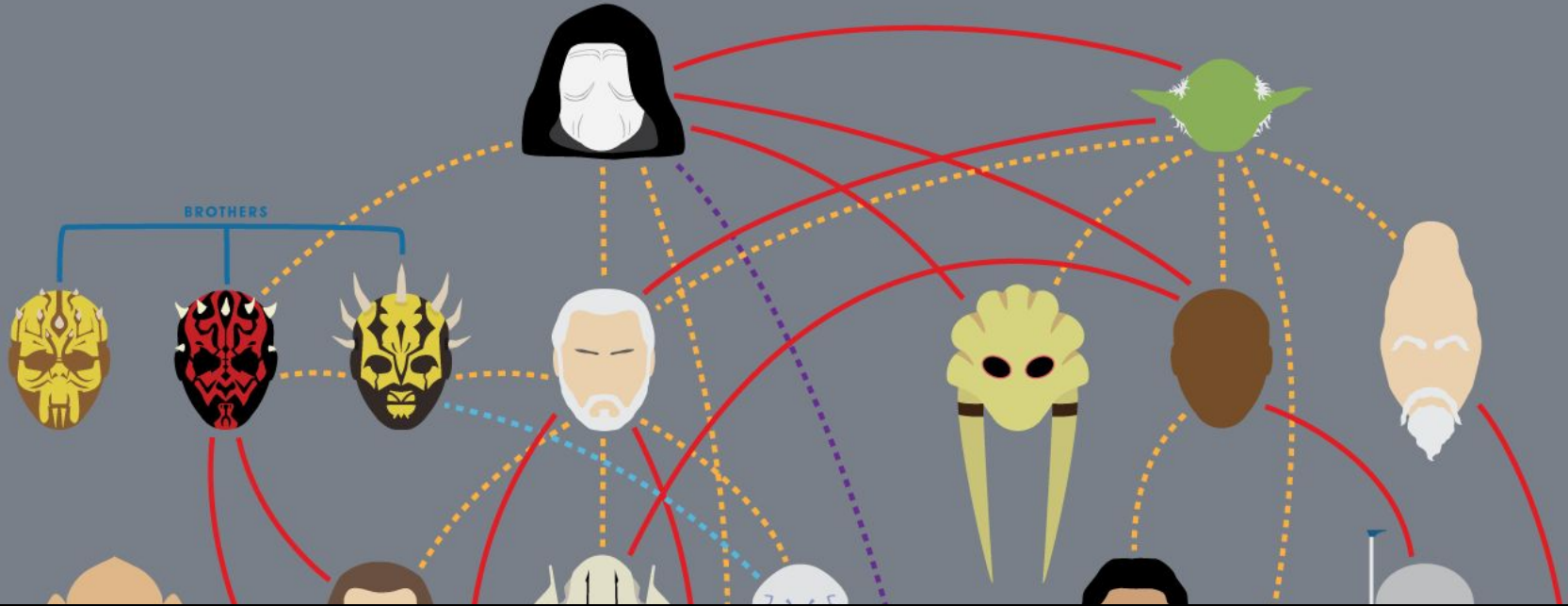

Automatically updated

DROID FACTORY

- Robot parts and pieces interchangeable.
- Build up to 5 different robots at the same time.
- Make hundreds of different combinations.
- Robot building instruction blueprint booklet included.
- Build your own R2-D2 .

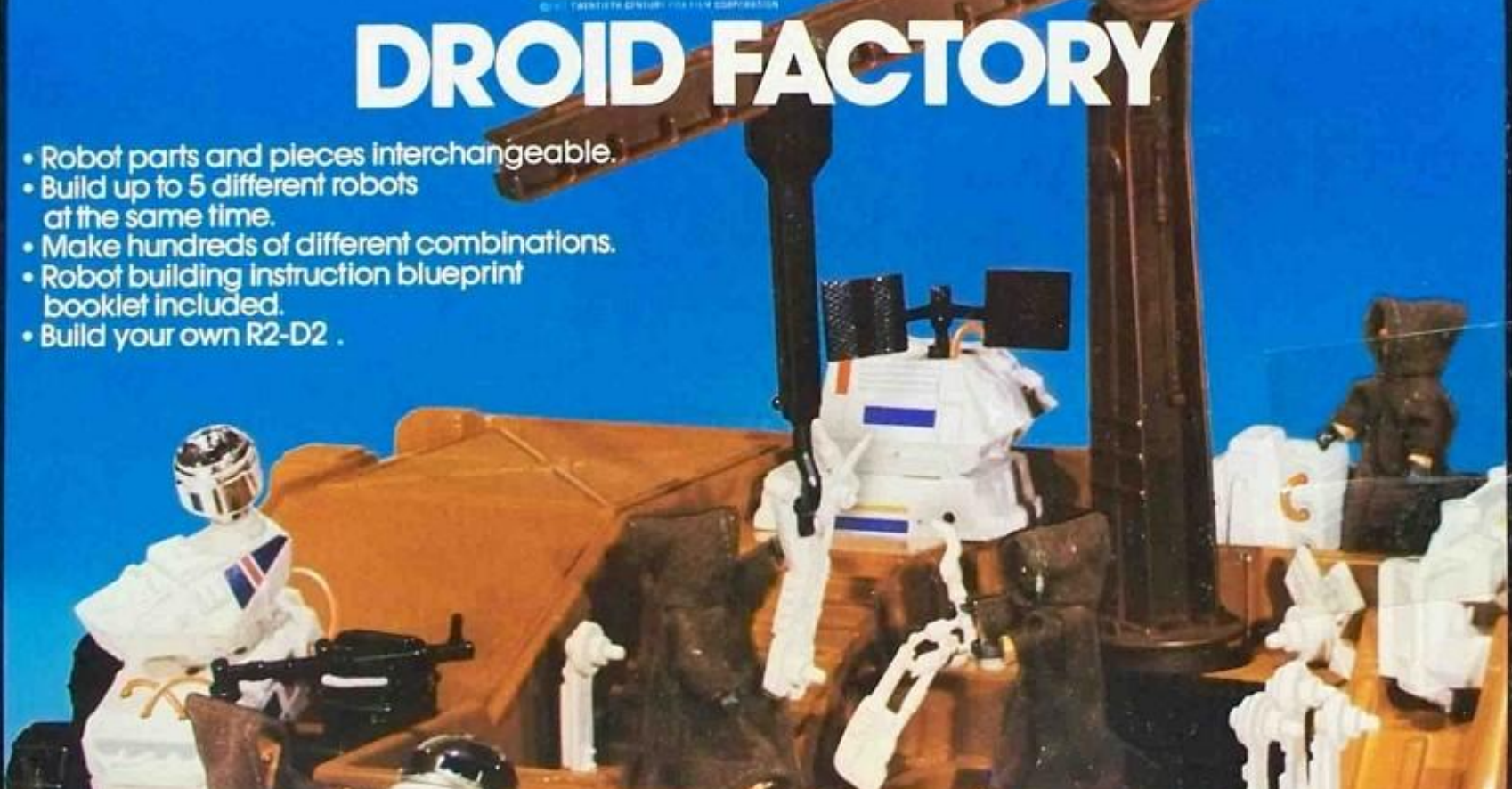

Documentation Factory

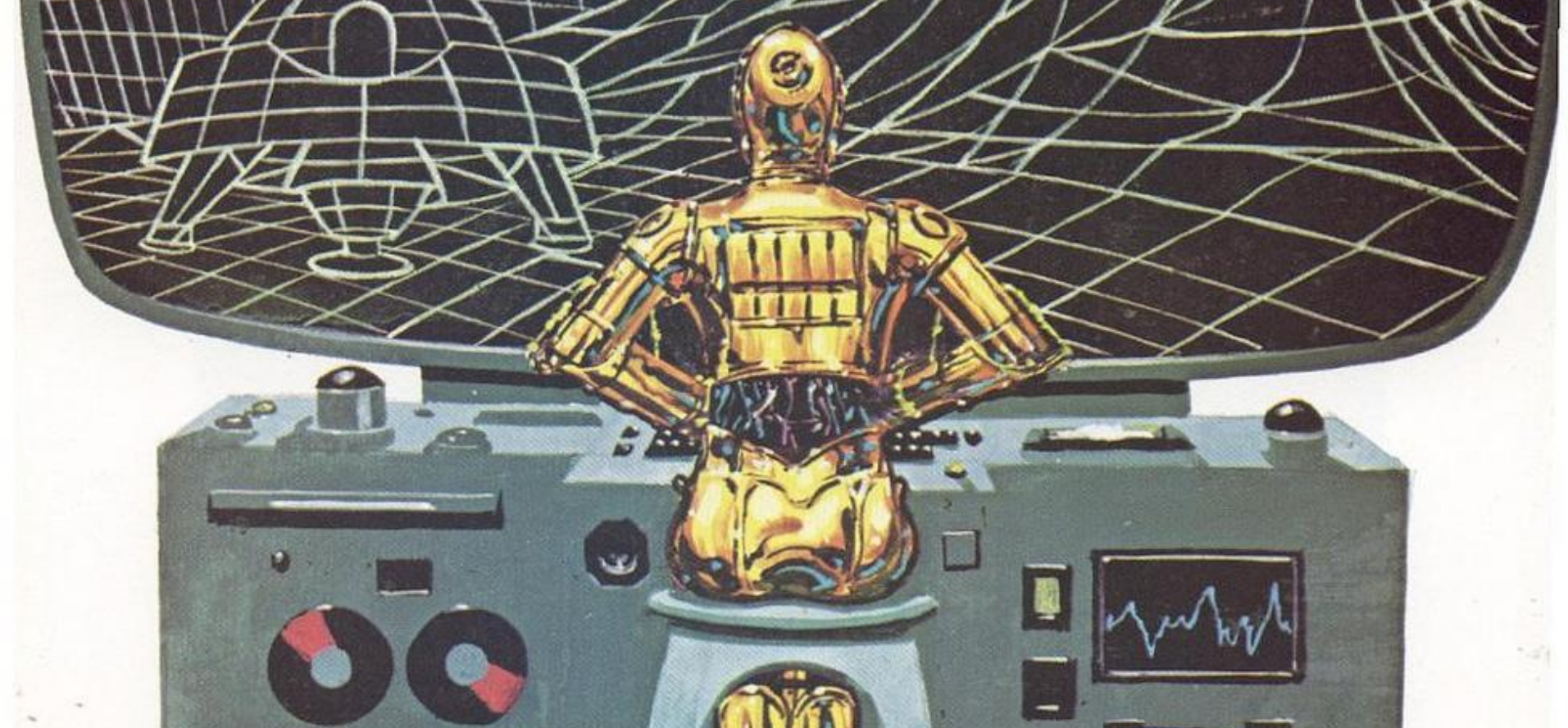

Integrated Documentation Environment



Documentation Continuous Delivery

TAKEAWAYS

- Episode I DOCUMENTATION MATTERS
- Episode II FIGHT UNREAD DOCUMENTATION
- Episode III TREAT DOCUMENTATION AS CODE

I

II

III

IV

V

VI

VII

Episode IV

A NEW DATA

It is a period of civil war. Thanks to 3DJS, rebel visualizations have won their first victory against the evil Prose documentation Empire.



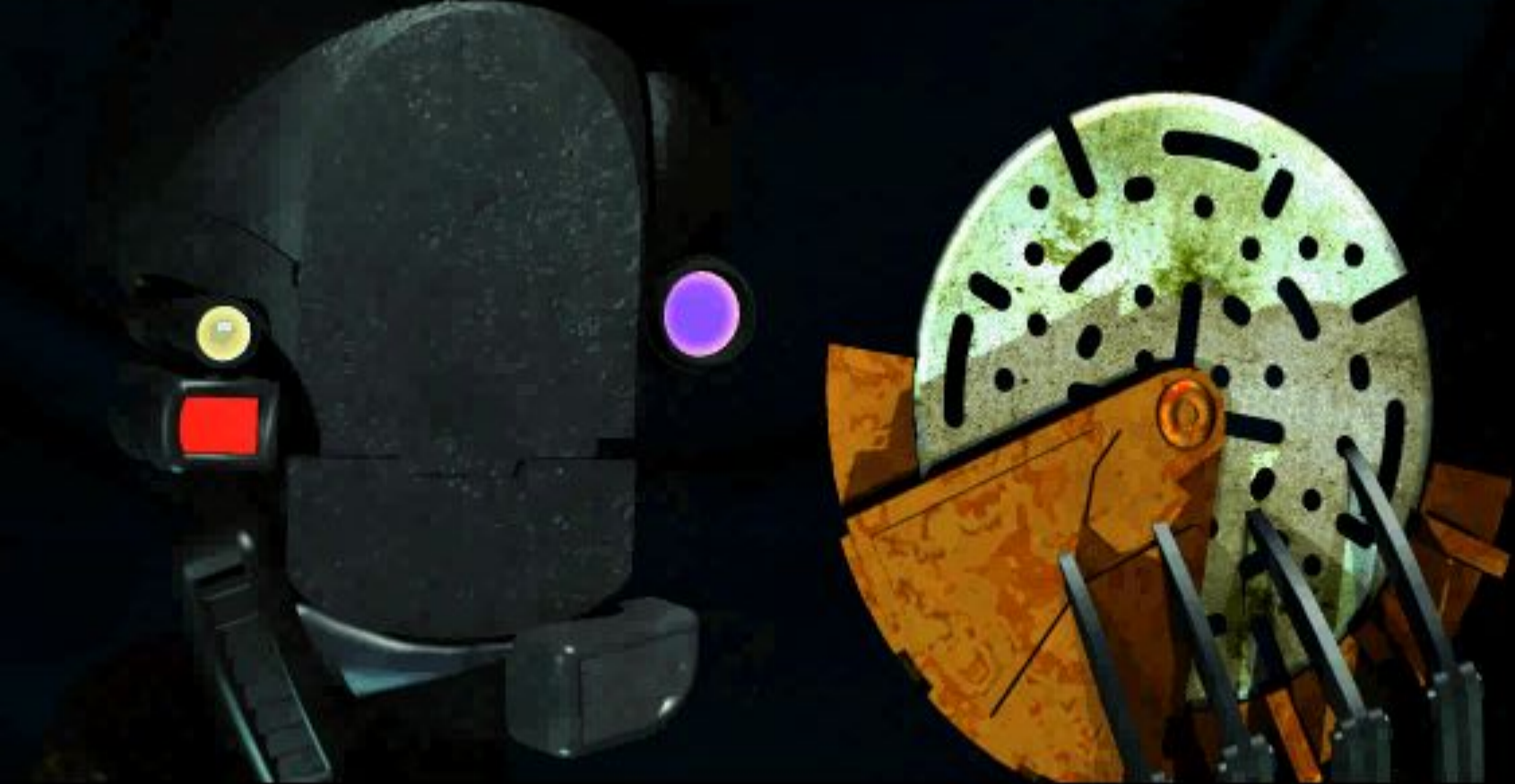

Documentation as Code

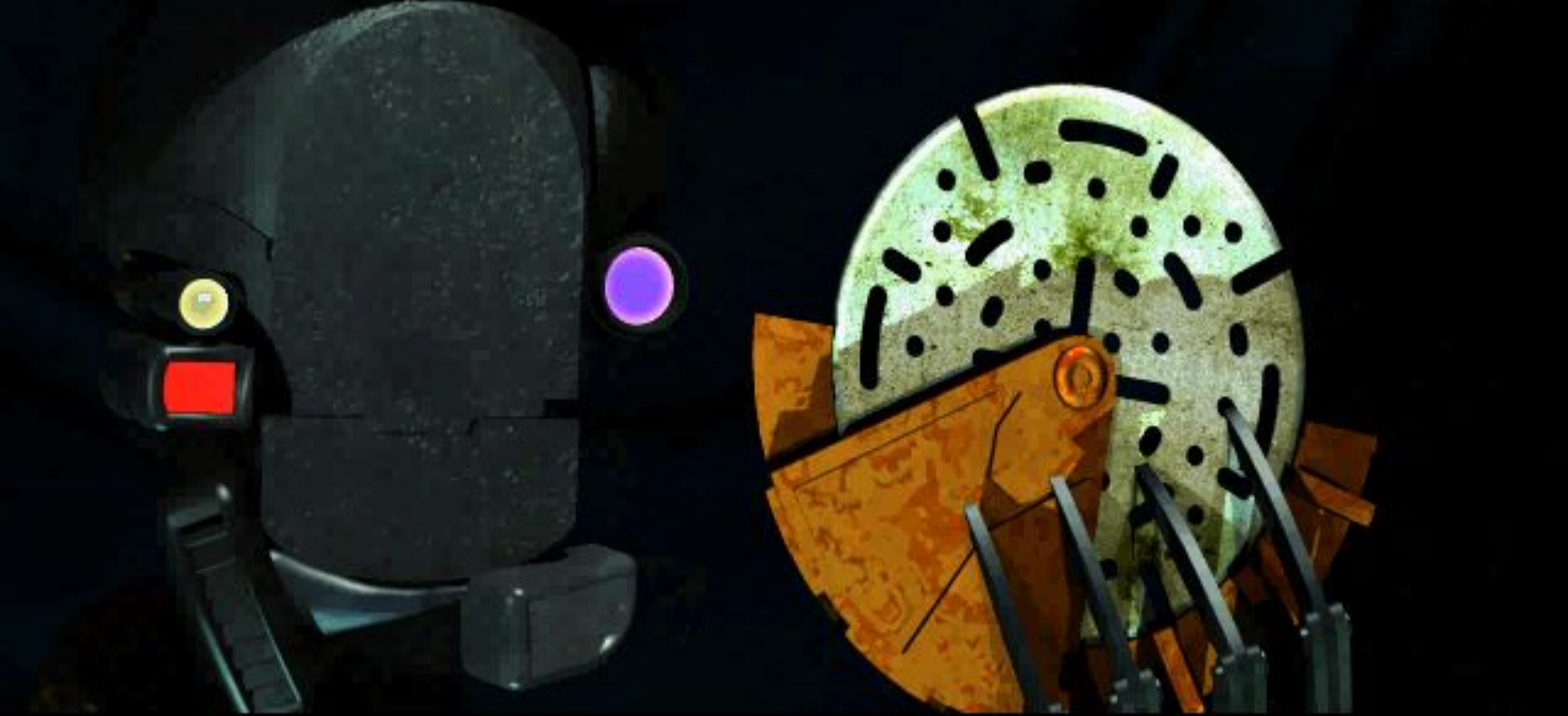

Documentation as Data

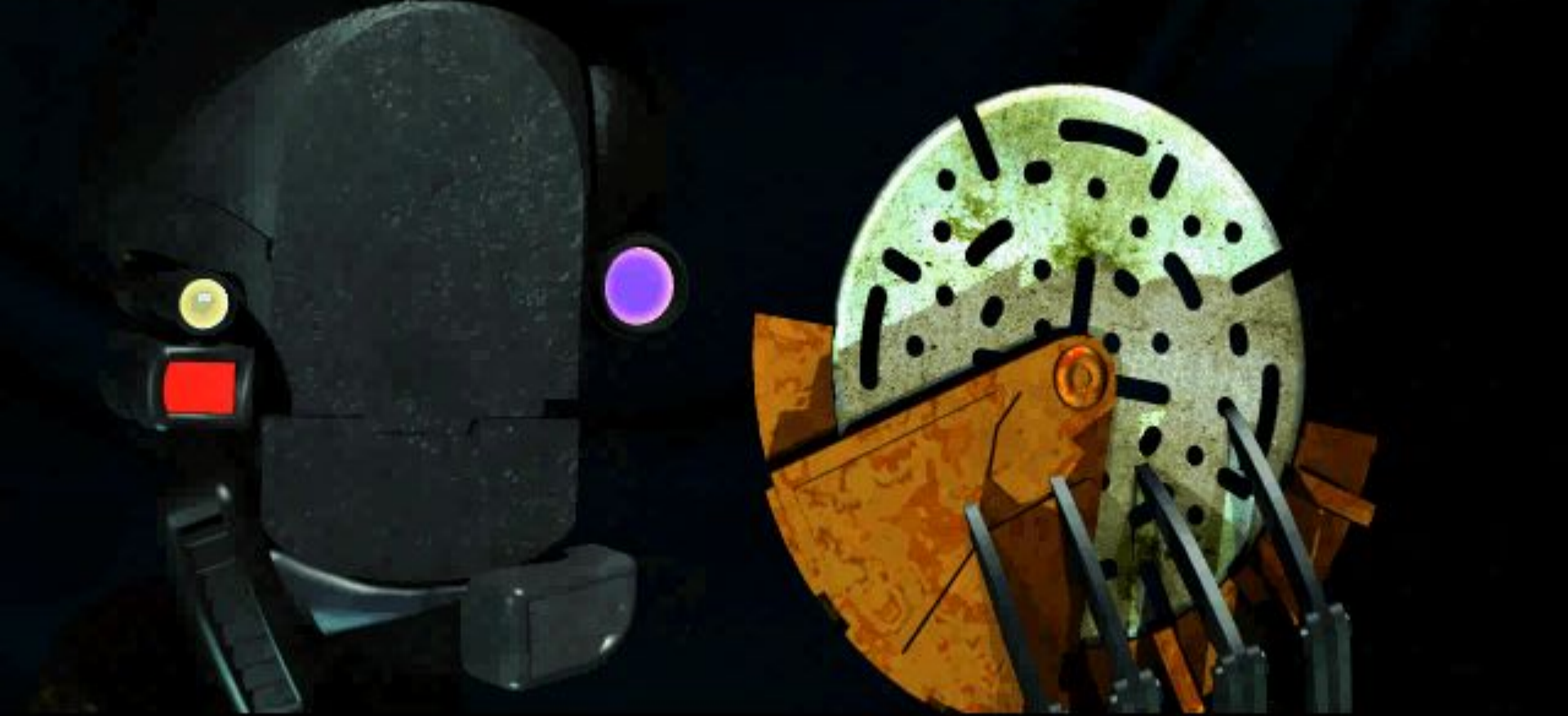

Documentation as API



Documentation visualization



Interactive Documentation Visualization

TAKEAWAYS

- Episode I DOCUMENTATION MATTERS
- Episode II THINK ABOUT AN IDEAL WORLD
- Episode III TREAT DOCUMENTATION AS CODE
- Episode IV USE DOCUMENTATION AS DATA

I

II

III

IV

V

VI

VII

Episode V

HUMAN STRIKES BACK

It is a dark time for the Documentation. API Descriptors have driven the Story Telling forces from their hidden base and pursued them across the galaxy.



Documentation is for people

/pzs

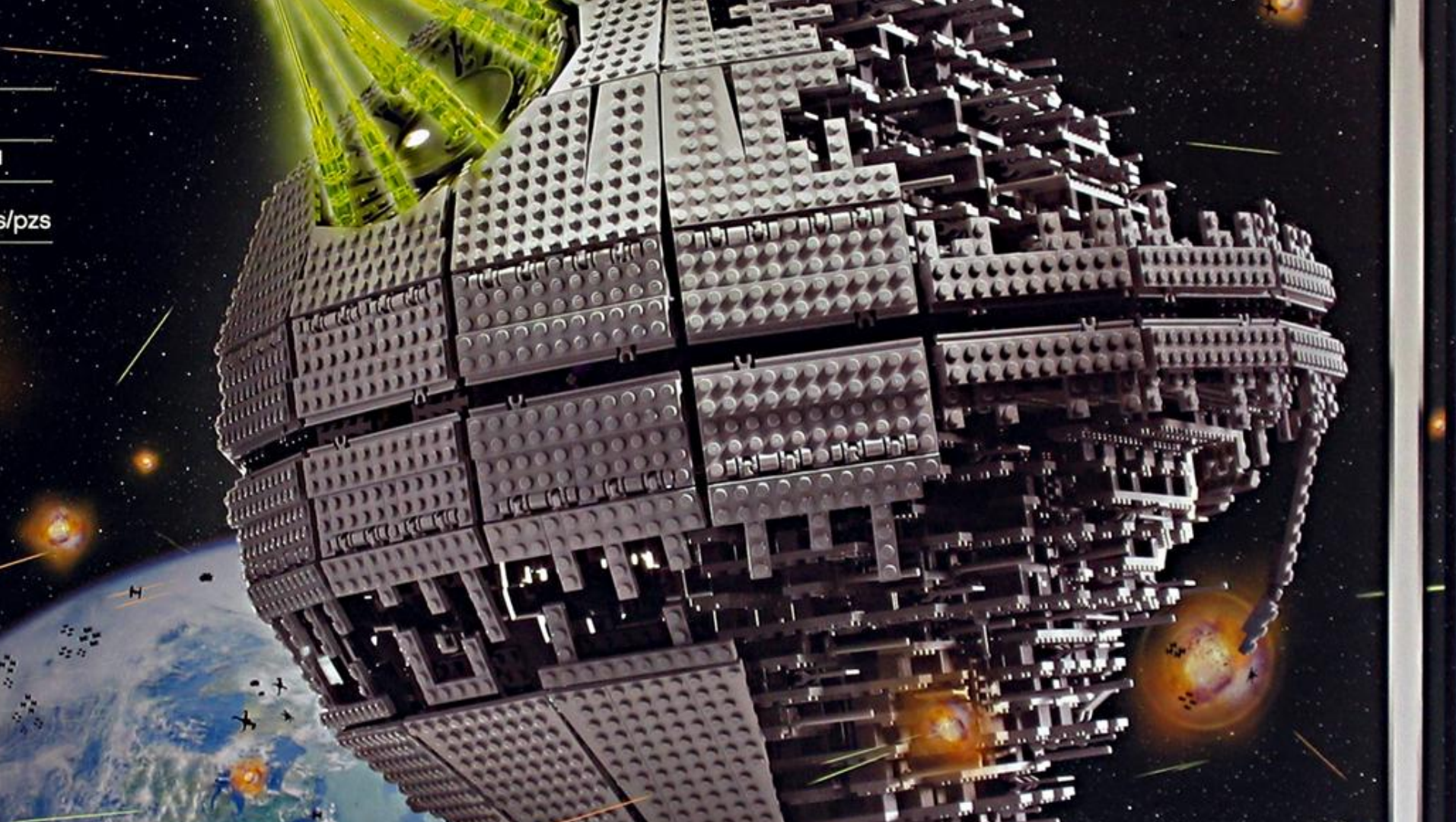



/pzs

less than 2000 pieces?



/pzs

more then 2000 thousand?



STAR WARS

ages/edades
16+
10143
Death Star II™
cont. **3449** pcs/pzs

Building Toy
Jouet de Construction
Juguete para Construir



[[List](#) | [List with Images](#)] --- [[Standard View](#) | [Break Sets](#)]

Image	Qty	Item No	Description
Regular Items:			
Parts:			
Yes	1	10143stk01	Sticker for Set 10143 - (48981/4270751)
Yes	10	3010	Black Brick 1 x 4
Yes	4	3008	Black Brick 1 x 8
Yes	6	6112	Black Brick 1 x 12
Yes	2	3001	Black Brick 2 x 4
Yes	10	3006	Black Brick 2 x 10
Yes	30	30236	Black Brick, Modified 1 x 2 with Handle
Yes	4	41855	Black Brick, Modified 2 x 2 x 2/3 Two Studs, L
Yes	1	2434	Black Brick, Modified 2 x 4 x 2 with Studs on
Yes	18	6134	Black Hinge Brick 2 x 2 Top Plate Thin
Yes	1	44567	Black Hinge Plate 1 x 2 Locking with 1 Finger
Yes	32	4477	Black Plate 1 x 10
Yes	28	3034	Black Plate 2 x 8
Yes	2	3832	Black Plate 2 x 10
Yes	33	3032	Black Plate 4 x 6
Yes	2	3030	Black Plate 4 x 10
Yes	2	3029	Black Plate 4 x 12
Yes	11	3297	Black Slope 33 3 x 4
Yes	1	3037	Black Slope 45 2 x 4
Yes	1	4871	Black Slope, Inverted 45 4 x 2 Double
Yes	2	3705	Black Technic Axle 4

3349 pieces



STAR WARS™

ages/edades
16+
10143
Death Star II™
cont. **3449** pcs/pzs

Building Toy
Jouet de Construction
Juguete para Construir

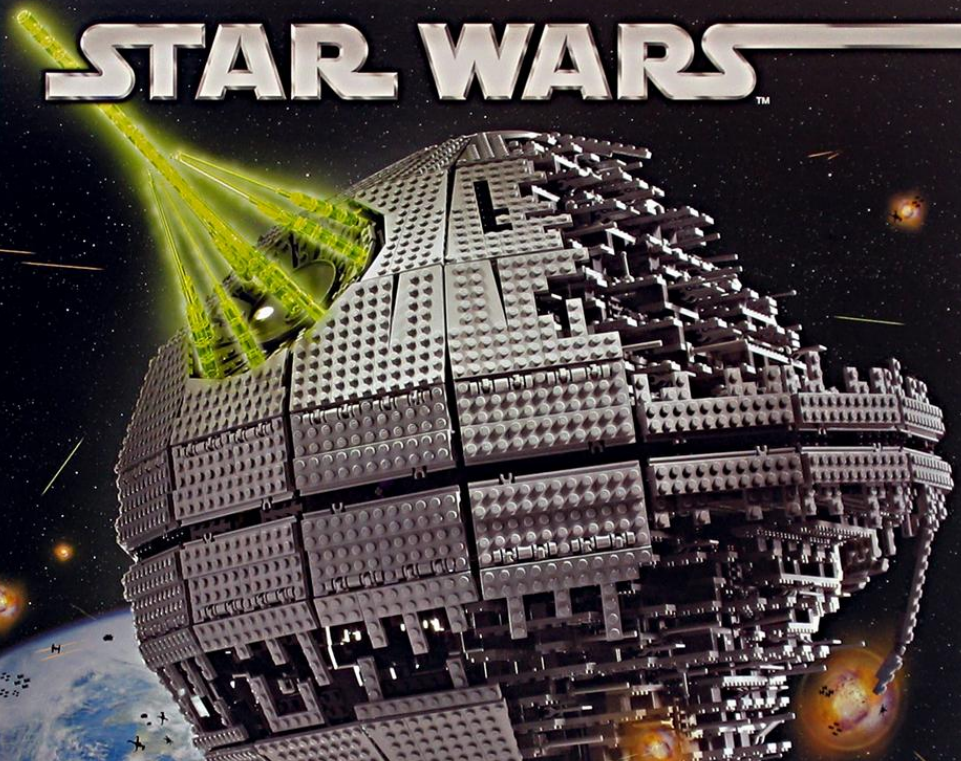

Image	Qty	Item No	Description
Regular Items:			
Parts:			
Yes	1	10143stk01	Sticker for Set 10143 - (48981/4270751)
Yes	10	3010	Black Brick 1 x 4
Yes	4	3008	Black Brick 1 x 8
Yes	6	6112	Black Brick 1 x 12
Yes	2	3001	Black Brick 2 x 4
Yes	10	3006	Black Brick 2 x 10
Yes	30	30236	Black Brick, Modified 1 x 2 with Handle
Yes	4	41855	Black Brick, Modified 2 x 2 x 2/3 Two Studs, L
Yes	1	2434	Black Brick, Modified 2 x 4 x 2 with Studs on
Yes	18	6134	Black Hinge Brick 2 x 2 Top Plate Thin
Yes	1	44567	Black Hinge Plate 1 x 2 Locking with 1 Finger
Yes	32	4477	Black Plate 1 x 10
Yes	28	3034	Black Plate 2 x 8
Yes	2	3832	Black Plate 2 x 10
Yes	33	3032	Black Plate 4 x 6
Yes	2	3030	Black Plate 4 x 10
Yes	2	3029	Black Plate 4 x 12
Yes	11	3297	Black Slope 33 3 x 4

An API descriptor is not THE end user's documentation

INCLUDES
Souvenir Photo Book

62103

THE STORY OF
STAR WARS

RETURN OF THE JEDI™

Dialogue and Music from
the Original Motion Picture Soundtrack



Story telling



Interactive Story telling



One size does not fit all

TAKEAWAYS

- Episode I DOCUMENTATION MATTERS
- Episode II FIGHT UNREAD DOCUMENTATION
- Episode III TREAT DOCUMENTATION AS CODE
- Episode IV USE DOCUMENTATION AS DATA
- Episode V DOCUMENTATION IS FOR PEOPLE TOO

I

II

III

IV

V

VI

VII

Episode VI

RETURN OF THE META

Master Lin Kane has returned to his home planet of Hypermedia, to forge the ultimate documentation APISJSON in a attempt to rescue the API providers from the clutches of the vile gangster Jabba the

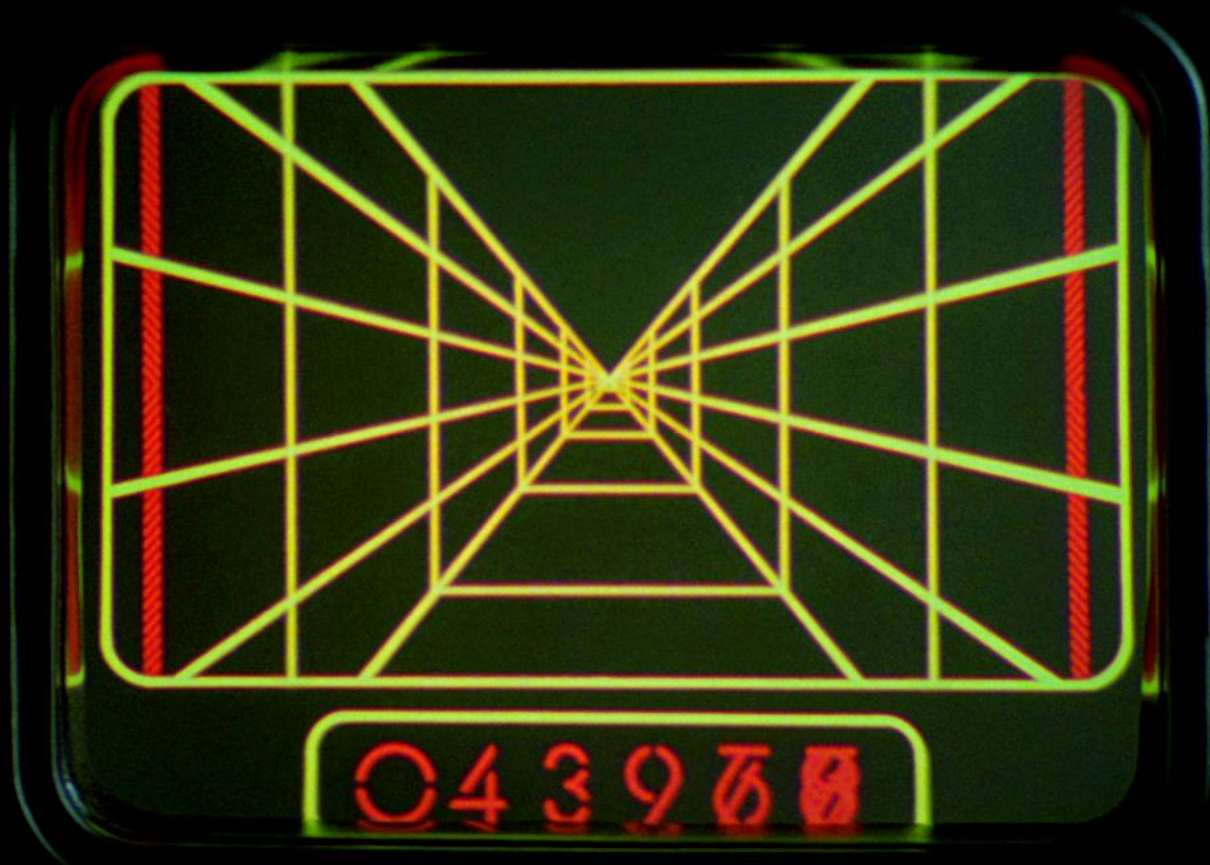
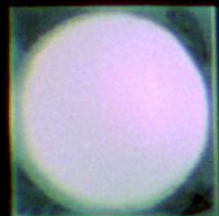



Hyperdocumentation



Hypermedia



Content negotiation



[application/json+documentation](#)



[documentation/tutorial+video](#)



Metadocumentation

TAKEAWAYS

- Episode I DOCUMENTATION MATTERS
- Episode II FIGHT UNREAD DOCUMENTATION
- Episode III TREAT DOCUMENTATION AS CODE
- Episode IV USE DOCUMENTATION AS DATA
- Episode V DOCUMENTATION IS FOR PEOPLE TOO
- Episode VI PROVIDE META DOCUMENTATION

I

II

III

IV

V

VI

VII

Episode VII

APIVERSE AWAKENS

***Is this only a dream? Is this only
a utopia?***

***Will the API community find out
how to achieve API and
documentation symbiosis...***



I can't believe it.
This is why you fail.

SO MANY SEEDS

Meta documentation	APIS.JSON ...
Text documentation	MARKDOWN ASCIIDOC YAML ...
Visualizations	3DJS MERMAID UNITY ...
API descriptors and tools	SWAGGER RAML BLUEPRINT ...
Hypermedia and tools	SIREN HAL HYDRA UBER ...
Data and dependancies	NEO4J NPM PIP RUBYGEMS ...
CI and CD tools	JENKINS GO CD ...
Concepts	TDD BDD UML MICROSERVICES ...
Documentation tools	ARDOQ CORILLA ...
...	...

TAKEAWAYS

- Episode I DOCUMENTATION MATTERS
- Episode II FIGHT UNREAD DOCUMENTATION
- Episode III TREAT DOCUMENTATION AS CODE
- Episode IV USE DOCUMENTATION AS DATA
- Episode V DOCUMENTATION IS FOR PEOPLE TOO
- Episode VI PROVIDE META DOCUMENTATION
- Episode VII THIS IDEAL IS WITHIN REACH

I

II

III

IV

V

VI

VII

Created by

@apihandyman ARNAUD LAURET

VERY SPECIAL THX

@paulsbruce PAUL BRUCE

@jkriggins JENNIFER K. RIGGINS

@kinlane KIN LANE

and GEORGE LUCAS

MAY THE DOCUMENTATION BE WITH YOUR API.
ALWAYS.

Join #APIDOCS